

# QIN 12/10

HAFNER

Kompaktný valec - UNITOP - vnútorný závit



## productDataPdf.propertiesHeader

Prípoj	M5
Závit piestnice	M3 - vnútorný závit
Pracovné médium	Stlačený vzduch
Ťažná sila (6 bar)	51 N
Piest	Magnetický
Materiál tesnenia	NBR, PU (max. 80°C)
Materiál krytu	Eloxovaný hliník
Priemer	Ø12
Teplotný rozsah	-20°C...+80°C
Materiál telesa valca	Eloxovaný hliník
Materiál piestu	Hliník
Materiál vodiaceho puzdra	Sintrovaný bronz
Priemer piestnice	Ø6 mm
Zdvih	10 mm
Pracovný tlak	1...10 bar
Prítlačná sila (6 bar)	68 N
Tlmenie	Flexibilné
Materiál piestnice	Nehrdzavejúca oceľ (AISI 304)
Funkcia	Dvojčinný

# QIN 12/10



HAFNER

Kompaktný valec - UNITOP - vnútorný závit

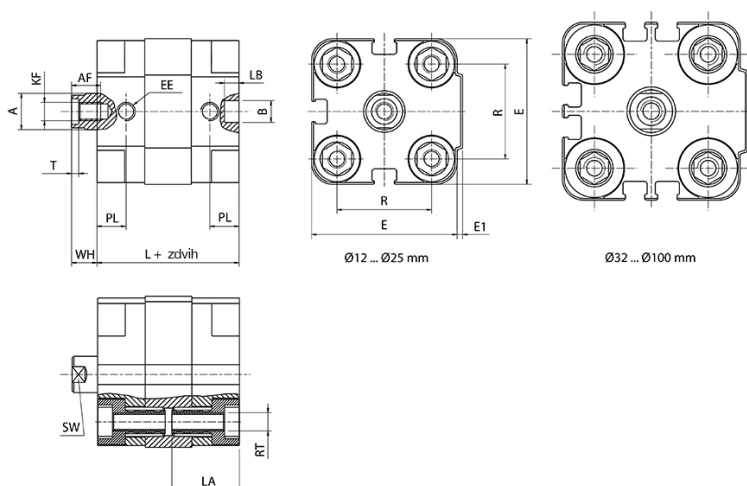

Typ	Ø [mm]	A	B	E	E1	L	R	T	AF	EE	KF	LA	LB	PL	RT	SW	WH
QIN 12/...	Ø 12	6	6	29	1	35	18	1,5	6	M 5	M 3	16	4	6,5	M 4	5	7,5
QIN 16/...	Ø 16	8	6	29	1	35	18	2	8	M 5	M 4	16	4	6,5	M 4	7	8,5
QIN 20/...	Ø 20	10	6	36	1,5	39	22	2	8	M 5	M 5	18,5	4	8	M 5	9	7
QIN 25/...	Ø 25	10	6	40	1,5	39	26	2	8	M 5	M 5	18,5	4	8	M 5	9	7
QIN 32/...	Ø 32	12	6	50	2	42	32	2,8	10	G 1/8"	M 6	21,5	4	6,5	M 6	10	7
QIN 40/...	Ø 40	12	6	60	2,5	45,5	42	2,8	10	G 1/8"	M 6	21,5	4	7,5	M 6	10	8,5
QIN 50/...	Ø 50	16	6	68	3	45,5	50	3,5	12	G 1/8"	M 8	23,5	4	7,5	M 8	13	10
QIN 63/...	Ø 63	16	8	87	4	51	62	3,5	12	G 1/8"	M 8	28,5	4	7,5	M 10	13	10,5
QIN 80/...	Ø 80	20	8	107	4	62	82	4,5	16	G 1/8"	M 10	28,5	4	9,5	M 10	17	13
QIN 100/...	Ø 100	25	8	128	5	68	103	6	20	G 1/4"	M 12	28,5	4	10,5	M 10	22	15,5