

ZINT 80/40

HAFNER

Kompaktný valec - ISO 21287 - s vedením



productDataPdf.propertiesHeader

Prípoj	G 1/8"
Závit piestnice	Zaistené proti pootočeniu
Pracovné médium	Stlačený vzduch
Ťažná sila (6 bar)	2685 N
Piest	Magnetický
Materiál tesnenia	NBR, PU (max. 80°C)
Materiál krytu	Eloxovaný hliník
Priemer	Ø80
Teplotný rozsah	-20°C...+80°C
Materiál telesa valca	Eloxovaný hliník
Materiál piestu	Hliník
Materiál vodiaceho puzdra	Sintrovaný bronz
Priemer piestnice	Ø20 mm
Zdvih	40 mm
Pracovný tlak	1...10 bar
Prítlačná sila (6 bar)	2864 N
Tlmenie	Flexibilné
Materiál piestnice	Tvrdo chrómovaná oceľ (CK45)
ISO norma	ISO 21287
Funkcia	Dvojčinný

ZINT 80/40



HAFNER

Kompaktný valec - ISO 21287 - s vedením

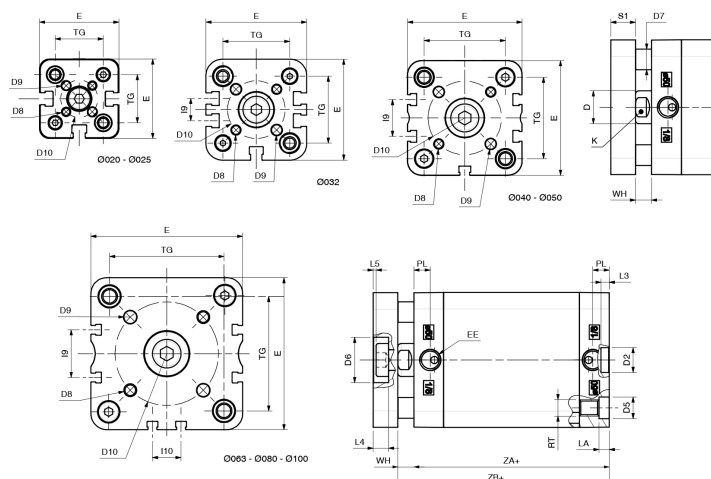

Typ	ZINT 20/...	ZINT 25/...	ZINT 32/...	ZINT 40/...	ZINT 50/...	ZINT 63/...	ZINT 80/...	ZINT 100/...
Ø	Ø20	Ø25	Ø32	Ø40	Ø50	Ø63	Ø80	Ø100
Ø D	10	10	12	12	16	16	20	25
Ø D2	9	9	9	9	12	12	12	12
Ø D5	7,5	7,5	9	9	10,5	10,5	13,5	13,5
Ø D6	11	14	17	17	22	22	28	30
Ø D7	5	6	6	8	10	10	14	14
D8	M4	M5	M5	M5	M6	M6	M8	M10
Ø D9	4	5	5	5	6	6	8	10
Ø D10	17	22	28	33	42	50	65	80
E	36	40	49	54,5	65,5	77	95,5	113,5
EE	M5	M5	G1/8	G1/8	G1/8	G1/8	G1/8	G1/8
I9	-	-	10,8	12,8	21	25,8	30	50
I10	-	-	-	-	-	13	18	35
K	8	8	10	10	13	13	17	22
LA	4,5	4,5	5	5	5	5	3	3
L3	3	3	3	3	4	4	4	4
L4	5	5	6,5	6,5	7,5	7,5	9	10
L5	1	1	1,5	1,5	1,5	1,5	2	3
PL	7,5	7,5	7,5	8	8	7,5	8	10,5
RT	M5	M5	M6	M6	M8	M8	M10	M10
S1	8	8	10	10	12	12	14	14
TG	22	26	32,5	38	46,5	56,5	72	89
WH	6,5	6	6,5	7	8	8	9	10
ZA+Zdvih	37	39	44	45	45	49	54	67
ZB+Zdvih	43,5	45	50,5	52	53	57	63	77