

PLF 50/00-900

HAFNER

Bezpečnostný pneumatický valec

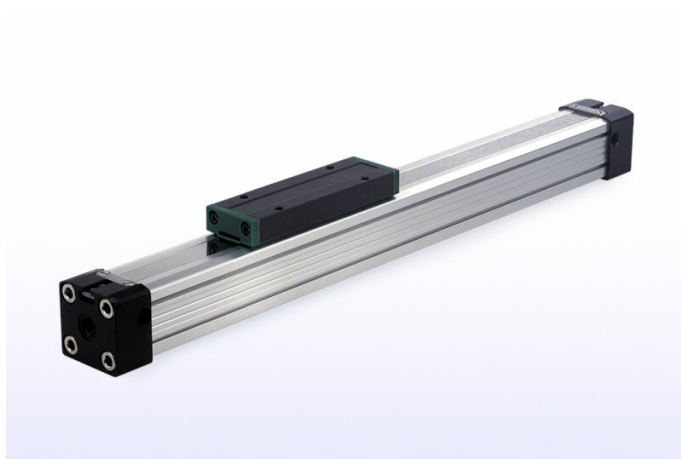

productDataPdf.propertiesHeader

Prípoj	G 1/4"
Pracovné médium	Stlačený vzduch
Piest	Magnetický
Materiál tesnenia	NBR
Materiál krytu	Eloxovaný hliník
Priemer	Ø50
Teplotný rozsah	-10°C...+80°C
Materiál telesa valca	Eloxovaný hliník
Zdvih	900 mm
Pracovný tlak	1...8 bar
Tlmenie	Nastaviteľné
Funkcia	Dvojčinný

PLF 50/00-900

HAFNER

Bezpečnostný pneumatický valec

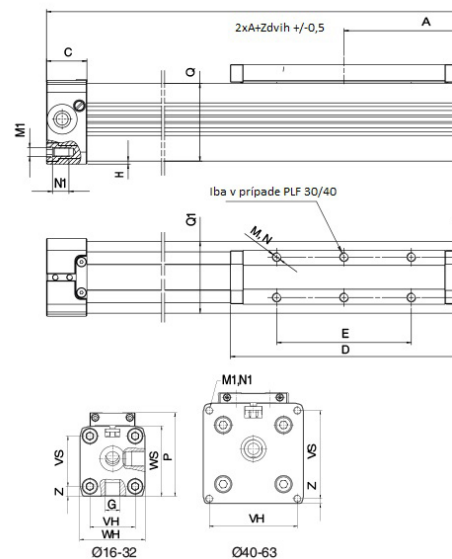
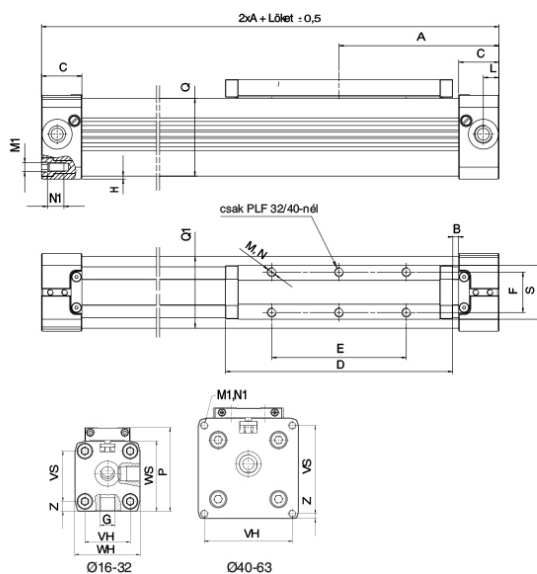

Typ	PLF16/...	PLF25/...	PLF32/...	PLF40/...	PLF50/...	PLF63/...
Ø [mm]	Ø16	Ø25	Ø32	Ø40	Ø50	Ø63
A	65	100	125	150	175	215
B	15,5	21	22	44	42	47,5
C	15	23	27	30	33	50
D	69	111	152	152	200	235
E	36	65	90	90	110	155
F	16,5	25	27	27	27	36
G	M5	G1/8	G1/4	G1/4	G1/4	G3/8
H	1	2	2	6,75	0,5	1,5
L	5,5	8,5	10,5	15	11,7	25
M	M4	M5	M6	M6	M6	M8
M1	M3	M5	M6	M6	M6	M8
N	7	10	7	10	6	15
N1	7	12	14	17	18	18
P	36,5	52,5	66,5	80	88	123
QxQ1	24,5x25	36x36	52x51	58,5x59	77x78	102x102
S	22	33	36	36,4	56	50
VS	18	27	40	54	70	78
VH	18	27	36	54	70	78
WS	27	40	56	69	80	106
WH	27	40	52	72	80	106
Z	4,5	6,5	8	9	4	14,5