

ZIN 63/100

HAFNER

Kompaktný valec - ISO 21287 - vnútorný závit



productDataPdf.propertiesHeader

Prípoj	G 1/8"
Závit piestnice	M10 - vnútorný závit
Pracovné médium	Stlačený vzduch
Ťažná sila (6 bar)	1661 N
Piest	Magnetický
Materiál tesnenia	NBR, PU (max. 80°C)
Materiál krytu	Eloxovaný hliník
Priemer	Ø63
Teplotný rozsah	-20°C...+80°C
Materiál telesa valca	Eloxovaný hliník
Materiál piestu	Hliník
Materiál vodiaceho puzdra	Sintrovaný bronz
Priemer piestnice	Ø16 mm
Zdvih	100 mm
Pracovný tlak	1...10 bar
Prítlačná sila (6 bar)	1776 N
Tlmenie	Flexibilné
Materiál piestnice	Tvrdo chrómovaná oceľ (CK45)
ISO norma	ISO 21287
Funkcia	Dvojčinný

ZIN 63/100



HAFNER

Kompaktný valec - ISO 21287 - vnútorný závit

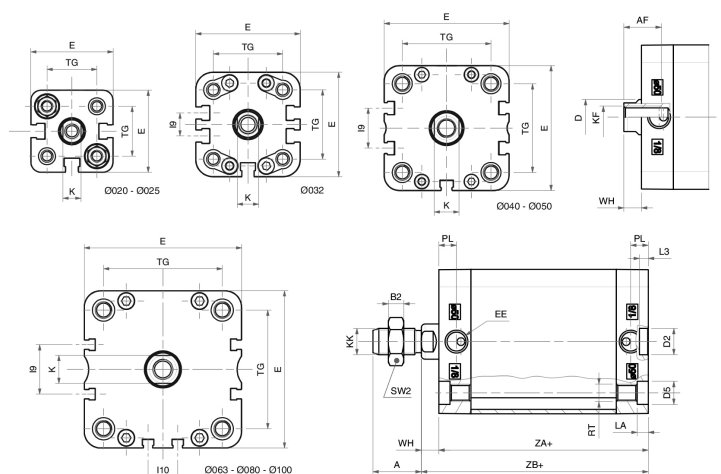

Typ	ZIN 20/...	ZIN 25/...	ZIN 32/...	ZIN 40/...	ZIN 50/...	ZIN 63/...	ZIN 80/...	ZIN 100/...
Ø	Ø20	Ø25	Ø32	Ø40	Ø50	Ø63	Ø80	Ø100
A	16	16	19	19	22	22	28	28
AF	15	15	15	15	17	17	20	22
B2	5	5	5	5	6	6	8	8
Ø D	10	10	12	12	16	16	20	25
Ø D2	9	9	9	9	12	12	12	12
Ø D5	7,5	7,5	9	9	10,5	10,5	13,5	13,5
E	36	40	49	54,5	65,5	77	95,5	113,5
EE	M5	M5	G1/8	G1/8	G1/8	G1/8	G1/8	G1/8
I9	-	-	10,8	12,8	21	25,8	30	50
I10	-	-	-	-	-	13	18	35
K	8	8	10	10	13	13	17	22
KF	M6	M6	M8	M8	M10	M10	M12	M12
KK	M8	M8	M10x1,25	M10x1,25	M12x1,25	M12x1,25	M16x1,5	M16x1,5
LA	4,5	4,5	5	5	5	5	3	3
L3	3	3	3	3	4	4	4	4
PL	7,5	7,5	7,5	8	8	7,5	8	10,5
RT	M5	M5	M6	M6	M8	M8	M10	M10
SW2	13	13	17	17	19	19	24	24
TG	22	26	32,5	38	46,5	56,5	72	89
WH	6,5	6	6,5	7	8	8	9	10
ZA+Zdvih	37	39	44	45	45	49	54	67
ZB+Zdvih	43,5	45	50,5	52	53	57	63	77