

HIF 100/2800

HAFNER

Normalizovaný valec - ISO 15552



productDataPdf.propertiesHeader

Prípoj	G 1/2"
Závit piestnice	M20 x 1,5 - vonkajší závit
ISO norma	ISO 15552 (v minulosti ISO 6431)
Pracovné médium	Stlačený vzduch
Ťažná sila (6 bar)	4195 N
Piest	Magnetický
Materiál tesnenia	NBR, PU (max. 80°C)
Materiál krytu	Hliníkový tlakový odliatok
Priemer	Ø100
Teplotný rozsah	-20°C...+80°C
Materiál telesa valca	Eloxovaný hliník
Materiál piestu	Hliník
Materiál vodiaceho puzdra	Sintrovaný bronz
Priemer piestnice	Ø25 mm
Pracovný tlak	1...10 bar
Prítlačná sila (6 bar)	4475 N
Tlmenie	Nastaviteľné
Materiál piestnice	Tvrdo chrómovaná oceľ (CK45)
Zdvih	2800 mm
Funkcia	Dvojčinný

HIF 100/2800



Normalizovaný valec - ISO 15552

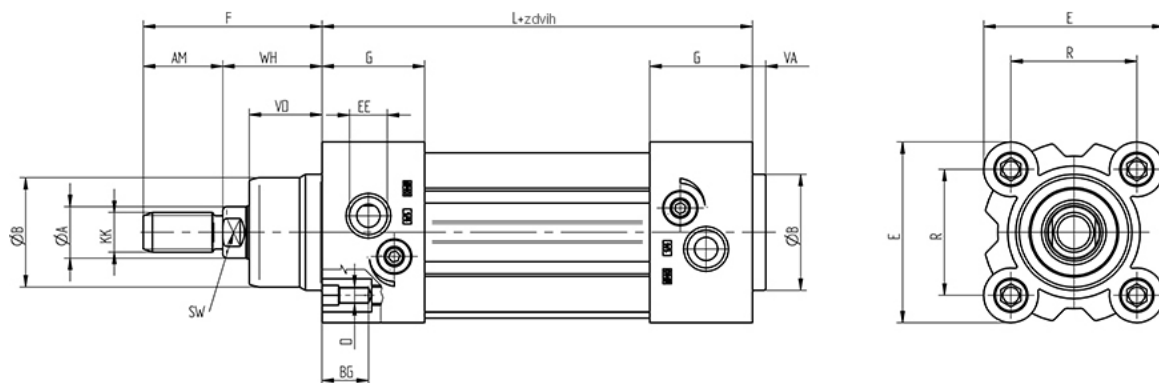

Typ	Ø [mm]	A	B	D	E	F	G	L	R	AM	BG	EE	KK	SW	VA	VD	WH
HIF 32/...	Ø 32	12	30	M 6	47	48	26,5	94	32,5	22	16	G 1/8"	M 10 x 1,25	10	4	18	26
HIF 40/...	Ø 40	16	35	M 6	54,5	54	31	105	38	24	16	G 1/4"	M 12 x 1,25	13	4	22	30
HIF 50/...	Ø 50	20	40	M 8	65	69	31	106	46,5	32	16	G 1/4"	M 16 x 1,5	17	4	25,5	37
HIF 63/...	Ø 63	20	45	M 8	75	69	33,5	121	56,5	32	16	G 3/8"	M 16 x 1,5	17	4	26	37
HIF 80/...	Ø 80	25	45	M 10	93	86	40	128	72	40	17	G 3/8"	M 20 x 1,5	22	4	32	46
HIF 100/...	Ø 100	25	55	M 10	110	91	40,5	138	89	40	17	G 1/2"	M 20 x 1,5	22	4	38	51
HIF 125/...	Ø 125	32	60	M 12	134	119	47	160	110	54	20	G 1/2"	M 27 x 2	27	6	46	65