

DIMX 80/200

HAFNER

Svorníkový valec - ISO 1552 - INOX



productDataPdf.propertiesHeader

Prípoj	G 3/8"
Závit piestnice	M20 x 1,5 - vonkajší závit
ISO norma	ISO 1552 (v minulosti ISO 6431)
Pracovné médium	Stlačený vzduch
Ťažná sila (6 bar)	2584 N
Piest	Magnetický
Materiál tesnenia	NBR, PU (max. 80°C)
Priemer	Ø80
Teplotný rozsah	-20°C...+80°C
Materiál telesa valca	Nehrdzavejúca oceľ
Materiál piestu	Hliník
Materiál vodiaceho puzdra	Sintrovaný bronz
Priemer piestnice	Ø25 mm
Zdvih	200 mm
Pracovný tlak	1...10 bar
Prítlačná sila (6 bar)	2864 N
Tlmenie	Nastaviteľné
Materiál piestnice	Nehrdzavejúca oceľ (AISI 304)
Materiál krytu	Nehrdzavejúca oceľ
Funkcia	Dvojčinný

DIMX 80/200



HAFNER

Svorníkový valec - ISO 15552 - INOX

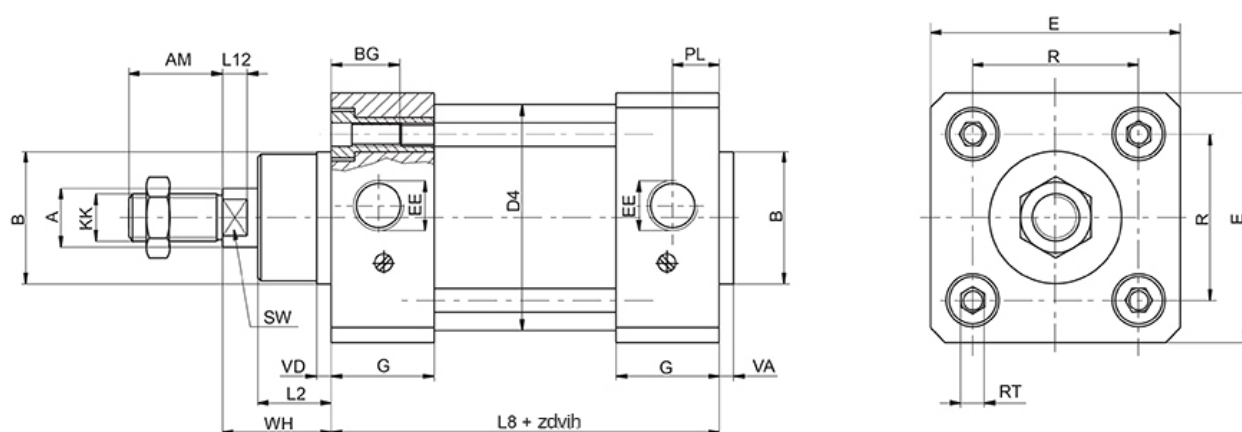

Typ	Ø [mm]	A	AM	B	BG	E	EE	G	KK	L2	L8	L12	PL	R	RT	SW	VA	VD	WH
DIMX 32/...	Ø 32	12	22	30	16	47	G 1/8"	31	M 10 x 1,25	16	94	6	11	32,5	M 6	10	4	5	26
DIMX 40/...	Ø 40	16	24	35	16	55	G 1/4"	34	M 12 x 1,25	20	105	6,5	13	38	M 6	13	4	5	30
DIMX 50/...	Ø 50	20	32	40	16	64	G 1/4"	36	M 16 x 1,5	25	106	8	14	46,5	M 8	16	4	5	37
DIMX 63/...	Ø 63	20	32	45	16	78	G 3/8"	40	M 16 x 1,5	25	121	8	16	56,5	M 8	16	4	5	37
DIMX 80/...	Ø 80	25	40	45	16	95	G 3/8"	42	M 20 x 1,5	32	128	10	16	72	M 10	21	4	5	46
DIMX 100/...	Ø 100	25	40	55	16	115	G 1/2"	45	M 20 x 1,5	35	138	10	18	89	M 10	21	4	5	51
DIMX 125/...	Ø 125	30	54	60	20	142	G 1/2"	53	M 27 x 2	40	160	10	20	110	M 12	27	6	6	65
DIMX 160/...	Ø 160	40	72	65	24	182	G 3/4"	59	M 36 x 2	38	180	12	27	140	M 16	38	6	6	80
DIMX 200/...	Ø 200	40	72	75	24	222	G 3/4"	61	M 36 x 2	55	180	12	35	175	M 16	38	6	6	95