

QINT 40/80

HAFNER

Kompaktný valec - UNITOP - s vedením



productDataPdf.propertiesHeader

Prípoj	G 1/8"
Závit piestnice	Zaistené proti pootočeniu
Pracovné médium	Stlačený vzduch
Ťažná sila (6 bar)	651 N
Piest	Magnetický
Materiál tesnenia	NBR, PU (max. 80°C)
Materiál krytu	Eloxovaný hliník
Priemer	Ø40
Teplotný rozsah	-20°C...+80°C
Materiál telesa valca	Eloxovaný hliník
Materiál piestu	Hliník
Materiál vodiaceho puzdra	Sintrovaný bronz
Priemer piestnice	Ø12 mm
Zdvih	80 mm
Pracovný tlak	1...10 bar
Prítlačná sila (6 bar)	716 N
Tlmenie	Flexibilné
Materiál piestnice	Tvrdo chrómovaná oceľ (CK45)
Funkcia	Dvojčinný

QINT 40/80

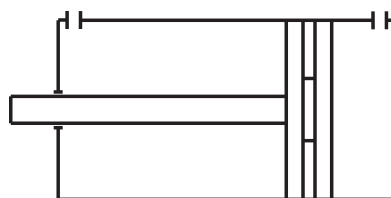

HAFNER

Kompaktný valec - UNITOP - s vedením

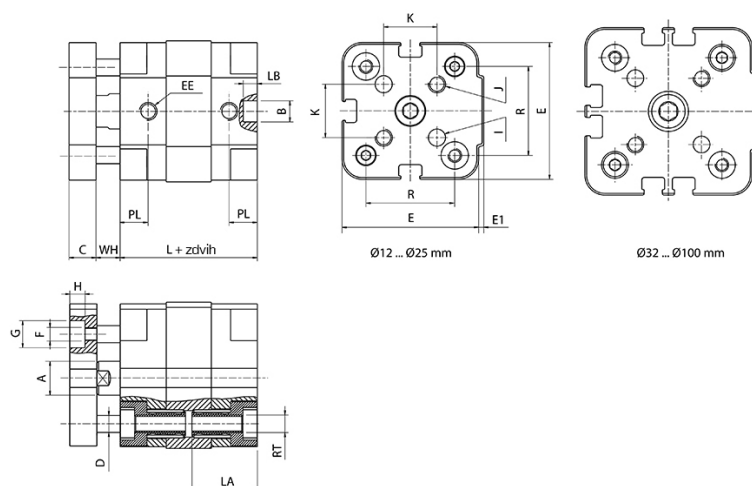

Typ	Ø [mm]	A	B	C	D	E	E1	F	G	H	I	J	K	L	R	EE	LA	LB	PL	RT	WH
QINT 12/...	Ø 12	6	6	5	4	29	1	M 3	6	3,5	3	M 3	9,9	35	18	M 5	16	4	6,5	M 4	7,5
QINT 16/...	Ø 16	8	6	5	4	29	1	M 3	6	3,5	3	M 3	9,9	35	18	M 5	16	4	6,5	M 4	8,5
QINT 20/...	Ø 20	10	6	8	6	36	1,5	M 3	6	3,5	4	M 4	12	39	22	M 5	18,5	4	8	M 5	7
QINT 25/...	Ø 25	10	6	8	6	40	1,5	M 4	8	4,5	5	M 5	15,6	39	26	M 5	18,5	4	8	M 5	7
QINT 32/...	Ø 32	12	6	10	6	50	2	M 4	8	5,5	5	M 5	19,8	42	32	G 1/8"	21,5	4	6,5	M 6	7
QINT 40/...	Ø 40	12	6	10	6	60	2,5	M 4	8	5,5	5	M 5	23,3	45,5	42	G 1/8"	21,5	4	7,5	M 6	8,7
QINT 50/...	Ø 50	16	6	12	8	68	3	M 6	11	7	6	M 6	29,7	45,5	50	G 1/8"	23,5	4	7,5	M 8	10,2
QINT 63/...	Ø 63	16	8	12	8	87	4	M 6	11	7	6	M 6	35,4	51	62	G 1/8"	28,5	4	7,5	M 10	10,5
QINT 80/...	Ø 80	20	8	14	12	107	4	M 8	14	9	8	M 8	46	62	82	G 1/8"	28,5	4	9,5	M 10	12
QINT 100/...	Ø 100	25	8	14	12	128	5	M 8	14	9	10	M 10	56,5	68	103	G 1/4"	28,5	4	10,5	M 10	15,5