

TQ-MS-4-1/8

HAFNER

Push-In závitová spojka Priamy tvar



productDataPdf.propertiesHeader

Prevedenie	Závitová
Materiál	Poniklovaná mosadz
Prípoj	G 1/8"
Pracovné médium	Stlačený vzduch, vákuum
Materiál tesnenia	NBR
Teplotný rozsah	-20°C...+80°C
Fixačná objímka	Poniklovaná mosadz
Materiál oporného krúžku	Poniklovaná mosadz
Materiál O krúžku	NBR
Materiál tela	Poniklovaná mosadz
Materiál upínacích pazúrov	Nehrdzavejúca oceľ
Priemer hadice	Ø4
Dostupnosť	Na sklade
Pracovný tlak	-0,9...20 bar

TQ-MS-4-1/8

HAFNER

Push-In závitová spojka Priamy tvar

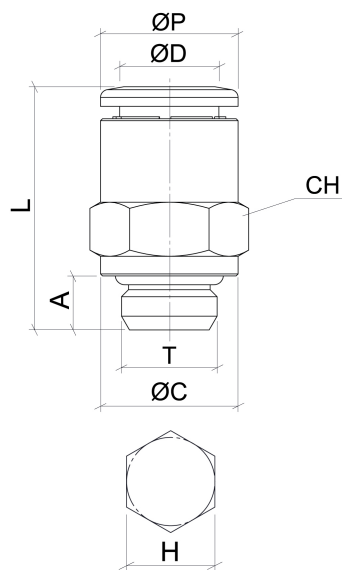

Typ	ØD	T	ØP	ØC	A	L	CH	H
TQ-MS-4-M5	4	M5x0,8	10	7	4	19	9	2,5
TQ-MS-4-1/8	4	G 1/8"	10	14	5,5	18	10	3
TQ-MS-4-1/4	4	G 1/4"	10	16	6,5	18	10	3
TQ-MS-6-M5	6	M5x0,8	12	7	4	21	11	2,5
TQ-MS-6-1/8	6	G 1/8"	12	14	5,5	19,5	12	4
TQ-MS-6-1/4	6	G 1/4"	12	16	6,5	19,5	12	4
TQ-MS-8-1/8	8	G 1/8"	14	14	5,5	24,5	14	5
TQ-MS-8-1/4	8	G 1/4"	14	16	6,5	21,5	14	6
TQ-MS-8-3/8	8	G 3/8"	14	20	7,5	21,5	14	6
TQ-MS-10-1/4	10	G 1/4"	16	16	6,5	27,5	16	7
TQ-MS-10-3/8	10	G 3/8"	16	20	7,5	25	16	8
TQ-MS-10-1/2	10	G 1/2"	16	25	9	25	16	8
TQ-MS-12-1/4	12	G 1/4"	19	16	6,5	30	19	6
TQ-MS-12-3/8	12	G 3/8"	19	22	7,5	29,5	19	10
TQ-MS-12-1/2	12	G 1/2"	19	25	9	28	19	10