

RIM 10/200

HAFNER

Kruhový valec - ISO 6432



productDataPdf.propertiesHeader

Prípoj	M5
Závit piestnice	M4 - vonkajší závit
ISO norma	ISO 6432
Pracovné médium	Stlačený vzduch
Piest	Magnetický
Materiál tesnenia	NBR, PU (max. 80°C)
Materiál krytu	Eloxovaný hliník
Priemer	Ø10
Teplotný rozsah	-20°C...+80°C
Materiál telesa valca	Nehrdzavejúca oceľ
Materiál piestu	Mosadz
Materiál vodiaceho puzdra	Sintrovaný bronz
Priemer piestnice	Ø4 mm
Zdvih	200 mm
Pracovný tlak	1...10 bar
Prítlačná sila (6 bar)	45 N
Tlmenie	Flexibilné
Materiál piestnice	Nehrdzavejúca oceľ (AISI 304)
Funkcia	Dvojčinný
Ťažná sila (6 bar)	38 N

RIM 10/200



HAFNER

Kruhový valec - ISO 6432

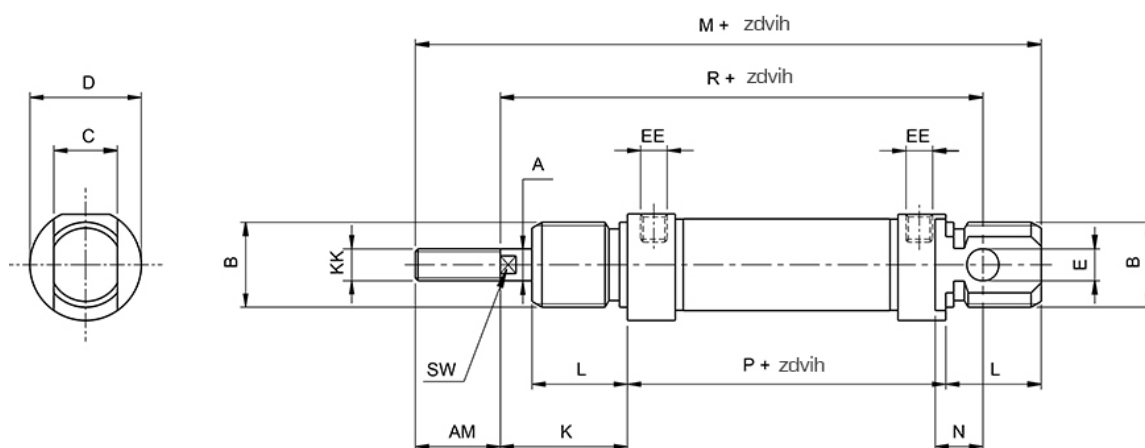

Typ	Ø [mm]	A	B	C	D	E	K	L	M	N	P	R	AM	EE	KK	SW
RIM 8/...	Ø 8	4	M 12 x 1,25	8	16	4	16	12	86	6	46	64	12	M 5	M 4	-
RIM 10/...	Ø 10	4	M 12 x 1,25	8	16	4	16	12	86	6	46	64	12	M 5	M 4	-
RIM 12/...	Ø 12	6	M 16 x 1,5	12	19	6	22	18	104	9	48	75	16	M 5	M 6	5
RIM 16/...	Ø 16	6	M 16 x 1,5	12	19	6	22	18	109	9	53	82	16	M 5	M 6	5
RIM 20/...	Ø 20	8	M 22 x 1,5	16	27	8	24	20	131	12	67	95	20	G 1/8"	M 8	7
RIM 25/...	Ø 25	10	M 22 x 1,5	16	30	8	28	22	140	12	68	104	22	G 1/8"	M 10 x 1,25	9