

TQ-ML-4-1/4

HAFNER

Push-In závitová spojka Kolenó



productDataPdf.propertiesHeader

Prevedenie	Závitová
Materiál	Poniklovaná mosadz
Prípoj	G 1/4"
Pracovné médium	Stlačený vzduch, vákuum
Materiál tesnenia	NBR
Teplotný rozsah	-20°C...+80°C
Fixačná objímka	Poniklovaná mosadz
Materiál oporného krúžku	Poniklovaná mosadz
Materiál O krúžku	NBR
Materiál tela	Poniklovaná mosadz
Materiál upínacích pazúrov	Nehrdzavejúca oceľ
Priemer hadice	Ø4
Dostupnosť	Na sklade
Pracovný tlak	-0,9...20 bar

TQ-ML-4-1/4

HAFNER

Push-In závitová spojka Koleno

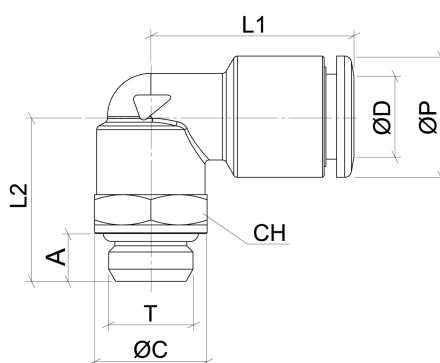

Typ	ØD	T	ØP	ØC	A	L1	L2	CH	g
TQ-ML-4-M5	4	M5x0,8	10	7	4	18	15	8	5
TQ-ML-4-1/8	4	G 1/8"	10	13	5,5	19,5	19	13	19
TQ-ML-4-1/4	4	G 1/4"	10	16	6,5	19,5	21,5	13	22
TQ-ML-6-M5	6	M5x0,8	12	7	4	19,5	16	8	11
TQ-ML-6-1/8	6	G 1/8"	12	13	5,5	21	19	13	20
TQ-ML-6-1/4	6	G 1/4"	12	16	6,5	21	21,5	13	24
TQ-ML-8-1/8	8	G 1/8"	14	13	5,5	23	19	13	22
TQ-ML-8-1/4	8	G 1/4"	14	16	6,5	23	21,5	13	24
TQ-ML-8-3/8	8	G 3/8"	14	20	7,5	23	23	13	28
TQ-ML-10-1/4	10	G 1/4"	16	16	6,5	26	23	16	35
TQ-ML-10-3/8	10	G 3/8"	16	20	7,5	26	26	16	43,5
TQ-ML-10-1/2	10	G 1/2"	16	25	9	26	27,5	16	52
TQ-ML-12-1/4	12	G 1/4"	19	16	6,5	31	25,5	20	55
TQ-ML-12-3/8	12	G 3/8"	19	20	7,5	31	26,5	20	55
TQ-ML-12-1/2	12	G 1/2"	19	25	9	31	29	20	63